



AC INFINITY

AIRCOM SERIES

COMPONENT COOLING SYSTEM

USER MANUAL

WELCOME

Thank you for choosing AC Infinity. We are committed to product quality and friendly customer service. If you have any questions or suggestions, please don't hesitate to [contact](#) us. Visit www.acinfinity.com and click contact for our contact information.

EMAIL

support@acinfinity.com

WEB

www.acinfinity.com

LOCATION

Los Angeles, CA

MANUAL CODE AC2010X1

PRODUCT

AIRCOM S6
AIRCOM S7
AIRCOM S8
AIRCOM S9
AIRCOM S10
AIRCOM T8
AIRCOM T9
AIRCOM T10

MODEL

AI-ACS6
AI-ACS7
AI-ACS8
AI-ACS9
AC-ACS10
AI-ACT8
AI-ACT9
AC-ACT10

UPC-A

854759004624
854759004631
854759004648
854759004655
819137020320
854759004662
854759004679
819137020313

MANUAL INDEX

Manual Index	Page 5
Product Requirements	Page 6
Key Features	Page 8
Product Contents	Page 9
Product Setup	Page 10
Programming (S6, S7, S8, S9, S10).....	Page 12
Programming (T8, T9, T10).....	Page 14
FAQ	Page 20
Other AC Infinity Products	Page 21
Warranty	Page 22

PRODUCT REQUIREMENTS

The AIRCOM series is designed to cool various AV components by accelerating the intake of cool air and outtake of heat. Please make sure that the following requirements are met to ensure the cooling system will work effectively.

FULLY ENCLOSED CABINETS

The cooling system is not compatible with fully enclosed cabinets. Air must be able to travel in and out of the cabinet. Please make sure that your cabinet has ventilation holes or is open at the front or back.

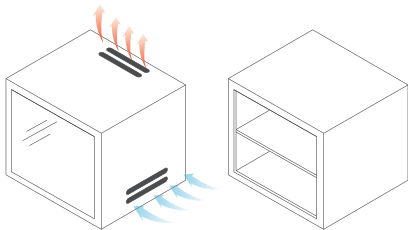

REAR EXHAUST MODELS

For models containing blowers, AIRCOM S6, S8, and T8, the cabinet's ventilation holes should be at the rear. The hot air that the cooling system is exhausting should be directed out of the cabinet through its rear holes.

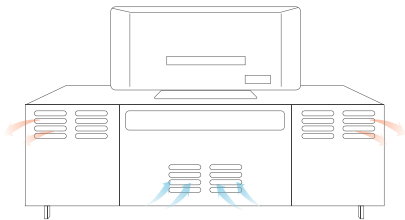

PRODUCT REQUIREMENTS

WEIGHT LIMITATIONS

AIRCOM S6, and S7 can support a top weight limit of 10 pounds. AIRCOM S8, S9, S10, T8, T9 and T10 can support a top weight limit of 30 pounds. Please make sure that the component does not block the cooling system cooling system's vents.

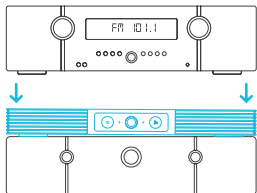

OPERATION LIMITATIONS

The fan system has an operating temperature rating of 32° F to 140° F and a humidity rating of 35% to 85% RH. Please make sure that the system's environment does not exceed these parameters.



COMPONENT VENTS

The cooling system is designed to be placed on top of AV components to draw out hot air upwards or at the rear. The system works more effectively if the AV component has vents at the top.

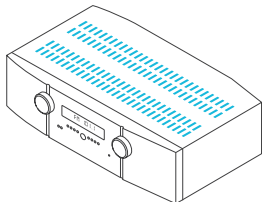

KEY FEATURES

STEEL ENCLOSURE

Cold-rolled steel enclosure enables additional AV components to be stacked on top of the cooling system.

NOISE REDUCTION

New and improved noise reduction using gaskets that absorbs noise caused by the fan's vibrations.

S SERIES CONTROLLER

Features fan speed control and a pre-set temperature trigger that turns the fans on at 88° F and off at 84° F.

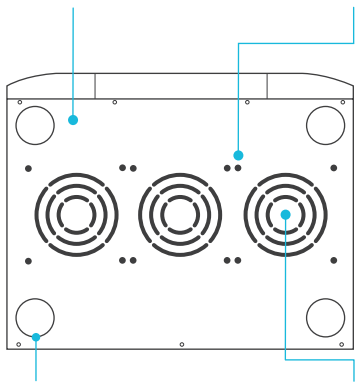

EXPANDABLE PORTS*

AIRPLATE and MULTIFAN fans can be plugged into the unit to share temperature and fan speed settings.

ULTRA-QUIET FANS

Fans are designed to maximize airflow CFM to noise dBA ratio. Contains long life dual-ball bearings.

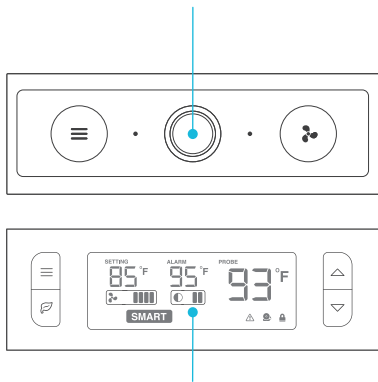

T SERIES CONTROLLER*

LCD display enables active temperature monitoring, thermal control, speed control, and SMART energy mode.

PRODUCT CONTENTS

AIRCOM S6 AI-ACS6
AIRCOM S7 AI-ACS7

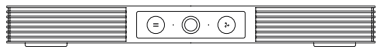

COOLING FAN SYSTEM (x1)



POWER ADAPTER (x1)

AIRCOM S8 AI-ACS8
AIRCOM S9 AI-ACS9
AIRCOM S10 AC-ACS10



COOLING FAN SYSTEM (x1)



POWER ADAPTER (x1)

AIRCOM T8 AI-ACT8
AIRCOM T9 AI-ACT9
AIRCOM T10 AC-ACT10

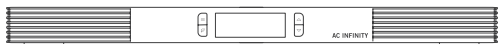

COOLING FAN SYSTEM (x1)

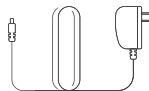

POWER ADAPTER (x1)

PRODUCT SETUP

STEP 1

Insert the AC plug of your power adapter into a power outlet.

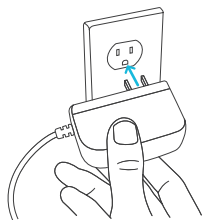

STEP 2

Plug the male connector of the adapter into the female connector located on the backside of the cooling fan system.

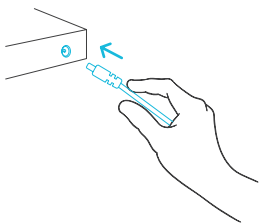

PRODUCT SETUP

STEP 3

Place the cooling fan system on top of your AV component.

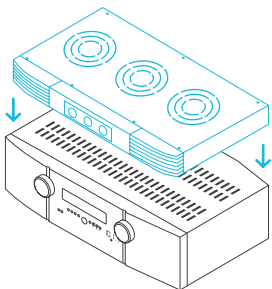

STEP 4

Set up the cooling fan system's temperature and speed settings on the control module. Refer below to see the model and instructions to follow.

AIRCOM S6, S7, S8, S9, S10

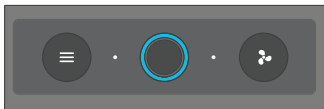

Please refer to Page 12 for instructions.

AIRCOM T8, T9, T10

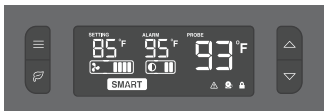

Please refer to Page 14 for instructions.

PROGRAMMING

AIRCOM S6 S7 S8 S9 S10

MODE CONTROL BUTTON

Pressing this button will cycle through the modes: ON Mode, AUTO Mode, SMART Mode, OFF Mode.

SPEED CONTROL BUTTON

Pressing this button changes the speed settings while the fans are running in ON, AUTO, and SMART Mode.

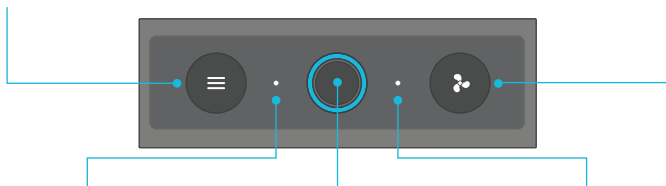

AUTO MODE LIGHT

This orange light indicates if the system is running in AUTO Mode.

FAN SPEED LIGHT

Indicates fan speed; and also the speed settings of AUTO and SMART Mode.

ON MODE LIGHT

This white light indicates if the system is running in ON Mode.

SMART AND OFF MODE LIGHT

Both the orange and white light will be visible when the controller is in SMART Mode. When both lights are not visible, the controller is in OFF Mode.

FAN SPEED LIGHT OPTIONS

The fan speed light displays the current speed of the fan. However, the light can also be set to become invisible automatically when you are not changing the speed settings. Holding the mode control button for three seconds will alternate between these two setting options.

PROGRAMMING

AIRCOM S6 S7 S8 S9 S10

MODE CONTROL

Pressing the Mode Control button will cycle through the operating modes: ON Mode, AUTO Mode, SMART Mode and OFF Mode.

ON MODE - A white light as shown on page 12 indicates if the system is running in ON Mode. In this mode, the fans will run continuously regardless of temperature.

AUTO MODE - An orange light as shown on page 12 indicates if the system is running in AUTO Mode. In this mode, the fans will only be triggered to run when the temperature is at 88° F or higher. While running, the fans will turn off when the temperature is at 84° F or lower.

SMART MODE - Both the orange and white light will be visible to indicate if the system is running in SMART Mode. In this mode the fans will change speed depending on the measured temperature. For every 2° F increment that the temperature is below 88° F, the speed of the fans will decrease by one level.

OFF MODE - In this mode, the white and orange light will not be visible; and the fans will not run regardless of temperature.



SPEED CONTROL

While in ON, AUTO, or SMART Mode, you can press this button to change the speed settings. In ON Mode, you can set what speed the fans will run continuously at. In AUTO Mode, pressing this button will set what speed the fans will run at when they are triggered to run. In SMART Mode, the speed you set will be the highest speed the fans can reach at 88° F; and drop by one level for every 2° F decrease.



PROGRAMMING

AIRCOM T8 T9 T10

1. MODE BUTTON

Cycles through the unit's modes: AUTO, SMART, OFF, ON, ALARM. Holding for three seconds will lock or unlock the display.

2. UP / DOWN BUTTON

The up and down buttons changes the setting temp, alarm temp, display brightness, or the speed of the fan.

3. LEAF BUTTON

This turns the display off while programs run in the background. Holding will change degrees to Fahrenheit or Celsius.

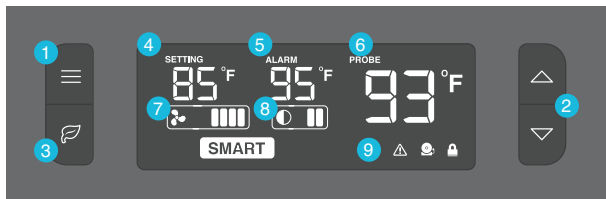

4. SETTING TEMP

Shows the temperature you set the fans to trigger in AUTO and SMART Mode.

5. ALARM TEMP

Shows the temperature that you set the fan's alarm system to trigger.

6. PROBE TEMP

Actively shows current temperature that the probe is measuring.

7. FAN SPEED

Shows what speed the fans are currently running at. Six speeds are available.

8. BRIGHTNESS

Shows the brightness of the display. Four settings are available.

9. ALERT ICONS

Flashes to indicate if check fan alert, or display lock is being triggered.

PROGRAMMING

AIRCOM T8 T9 T10

QUICK START

Press the MODE button until you are on AUTO mode. This mode works like a thermostat. Then press the up and down triangle buttons to change the SETTING temperature on the screen. The PROBE temperature is what the thermal probe is measuring. When the PROBE temperature exceeds the SETTING temperature, the fans will start running.

ON MODE

In this mode, the fans will run non-stop regardless of temperature. Pressing the up and down buttons while in this mode will change the speed of the fan. Whichever speed is designated in this mode will also be the speed used in AUTO Mode and the max speed of the fans in SMART Mode.

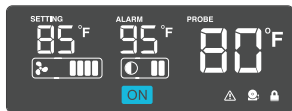

AUTO MODE

This is the thermostat setting where the fans will start running when the PROBE temperature reaches or surpasses the SETTING temperature. The SETTING temperature can be designated by pressing the up and down buttons while in this mode. Once the fans start running, the PROBE temperature would need to fall at least 4° F below the SETTING temp for the fans to stop running. This variation buffer can be changed to 2° F, see page 18 for more information.

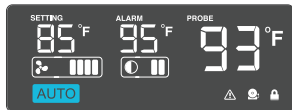
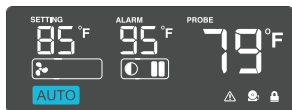

PROGRAMMING

AIRCOM T8 T9 T10

OFF MODE

In this mode, the fans are powered off regardless of set temperature or set speed. The backlight setting can be increased or decreased by pressing the up or down buttons while in this mode. If the first and the third brightness bar light up and the device is left unattended for 30 seconds, the display will automatically dim its brightness back to the dimmest setting.

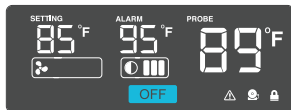

SMART MODE

This is the energy saving mode where the fans will change speed depending on the temperature. The SETTING temperature can be designated by pressing the up and down triangle buttons while in this mode.

For every 4°F increment that the PROBE temperature is below the SETTING temperature, the speed of the fans will decrease by one level. This increment can be changed to 2°F, please see page 18 for more information.

The fan speed you designated in ON Mode will also be the max speed the fan's can reach. This occurs when the PROBE temperature reaches or exceeds the SETTING temperature.

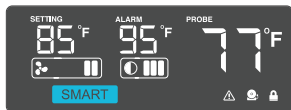
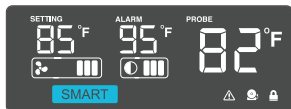
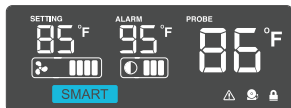

PROGRAMMING

AIRCOM T8 T9 T10

ALARM SETTING

In this mode, you can set what temperature the system's alarm will trigger by pressing the up and down triangle buttons. When the PROBE temperature reaches or exceeds the ALARM temperature, the alarm will activate. The alarm will only activate while the controller is in ON, AUTO, or SMART Mode so please remember to exit ALARM Mode once the alarm has been set.

When the alarm is triggered, the fan will run at max speed regardless of mode and will make an audible beep every three seconds. This will keep occurring until the temperature drops below the ALARM temp or if any buttons are pressed.

The alarm can be disabled to not trigger by pressing the up triangle button until the temperature is at 140° F, then pressing the up button once more to show "OF".

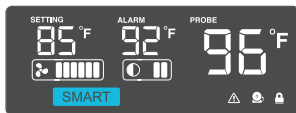
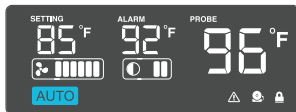
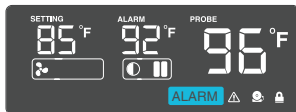

FAHRENHEIT OR CELSIUS

The temperatures displayed can be set to Fahrenheit or Celsius scale by holding the LEAF button until °F or °C is shown after the digits. All digits displayed will be automatically converted to the designated scale.

PROGRAMMING

AIRCOM T8 T9 T10

VARIATION BUFFER

In AUTO mode, a buffer is built in to prevent your fan from turning on and off too quickly due to small variations in the environment. When the PROBE temperature exceeds your SETTING temperature, the fan will start running immediately. However, the PROBE temperature will need to fall below your SETTING temperature by 4° Fahrenheit or 2° Celsius or more, to stop the fans from running. In SMART mode, the speed of the fan will decrease by one level for every 4° Fahrenheit or 2° Celsius that the PROBE temperature is below the SETTING temperature.

To change this buffer or increment setting to 2° Fahrenheit or 1° Celsius, hold the MODE button and DOWN button together for three seconds. To change back to 4° Fahrenheit or 2° Celsius, hold the MODE button and UP button together for three seconds.

CONTROLLER LOCK

Holding the MODE button for three or more seconds will lock the controller. The controller will still work as programmed. However, pressing any buttons will not have an effect and will cause the screen lock icon to flash. This option was designed to prevent your controller settings from being changed by accident. Holding the MODE button again for three or more seconds will unlock the controller.

CONNECTING MORE FANS

On the backside of the AIRCOM T8, T9, and T10 models, there are two USB ports. Up to six MULTIFAN or AIRPLATE fans can be plugged into it to share the same programming. A model can contain more than one fan. For example, an AIRPLATE S7 contains two fans so only three AIRPLATE S7s are supported. Before daisy chain one more fan, please make sure the previous fan speed is set on High speed. Please see page 20 for more information.

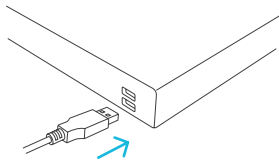

PROGRAMMING

AIRCOM T8 T9 T10

ALERT ICONS

On the bottom right of the display there are three alert icons. They are visible to show that the system's functions are being monitored. They will flash when the controller wishes to alert you that a particular function is being triggered.

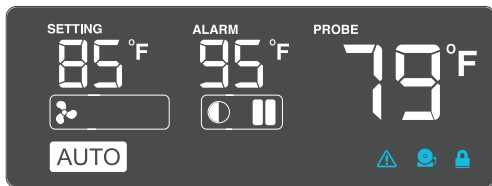

CHECK FAN ALERT

The check fan icon will flash when the fan's sensor detects interference to its operation. Please check the fan for possible issues. If the fan is rotating, it may just be static pressure resistance and operating as intended. If the fan is not rotating, please see the warranty page for replacement information.

ALARM ALERT

The alarm alert icon will flash when the probe temperature reaches or exceeds the alarm temperature you have set. Please see page 17 for more information on setting up the alarm.

DISPLAY LOCK ALERT

This icon is not visible when the controller is unlocked. The icon will flash when any buttons are pressed while the controller is locked. To lock or unlock the controller, hold down the MODE button for three or more seconds.



AIRCOM FAQ

Q: Is this fan capable of being rack mounted?

A: This fan is not specifically designed to be mounted in rack cabinets.

Q: How many fans can I connect to the expansion USB ports?

A: You may connect up to two MULTIFANS per USB port. This feature is only available in the AIRCOM T-Series.

Q: What is the biggest load I can stack on top of the AIRCOM?

A: 12" models can take up to 10 pounds of electronics and equipment on top of it. 17" models can take up to 30 pounds.

Q: How do I clean the fan blades?

A: Use compressed air to clear dust from the fans during maintenance. Do not disassemble the AIRCOM to dust the fans.

Q: Can I use the AIRCOM as a laptop cooler?

A: This product is not designed to be used as a laptop cooler. The fans cannot be flipped to create intake airflow instead of exhaust airflow.

Q: Will I be able to use this fan upside down?

A: We do not recommend flipping the unit upside down. The unit may not sit in place and would be in danger of slipping if placed a few feet from the ground.

AC INFINITY PRODUCTS

AIRPLATE SERIES

The AIRPLATE series is designed to cool home theater and audio video cabinets. The fans are powered by USB port or power outlets. Includes an inline speed controller and Boost Speed Adapter. The fans can also be temperature controlled with an Advance Thermal Controller (sold separately).

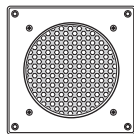

PRODUCT

AIRPLATE S1
AIRPLATE S3
AIRPLATE S5
AIRPLATE S7
AIRPLATE S9

MODEL

AI-CFS80BA
AI-CFS120BA
AI-CFD80BA
AI-CFD120BA
AI-APS9

DIMENSIONS

4.6 x 4.6 x 1.3 in.
6.3 x 6.3 x 1.3 in.
8.4 x 4.4 x 1.3 in.
11.7 x 6.1 x 1.3 in.
17.5 x 6.1 x 1.3 in.

MULTIFAN SERIES

The MULTIFAN series fans can be placed on top of AV components and electronics to exhaust hot air economically. It features an inline speed controller and can be powered by a USB port. The fans can also be powered through a power outlet with a Boost Speed Adapter (sold separately).

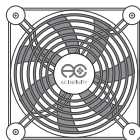

PRODUCT

MULTIFAN S1
MULTIFAN S3
MULTIFAN S4
MULTIFAN S5
MULTIFAN S7

MODEL

AI-MPF80A
AI-MPF120A
AI-MPF140A
AI-MPF80A2
AI-MPF120A2

DIMENSIONS

3.1 x 3.1 x 1 in.
4.7 x 4.7 x 1 in.
5.5 x 5.5 x 1 in.
3.1 x 3.1 x 1 in. /fan
4.7 x 4.7 x 1 in. /fan

WARRANTY

This warranty program is our commitment to you, the product sold by AC Infinity will be free from defects in manufacturing for a period of two years from the date of purchase. If a product is found to have a defect in material or workmanship, we will take the appropriate actions defined in this warranty to resolve any issues.

The warranty program applies to any order, purchase, receipt, or use of any products sold by AC Infinity or our authorized dealerships. The program covers products that have become defective, malfunctioned, or expressively if the product becomes unusable. The warranty program goes into effect on the date of purchase. The program will expire two years from the date of purchase. If your product becomes defective during that period, AC Infinity will replace your product with a new one or issue you a full refund.

The warranty program does not cover abuse or misuse. This includes physical damage, submersion of the product in water, incorrect installation such as wrong voltage input, and misuse for any reason other than intended purposes. AC Infinity is not responsible for consequential loss or incidental damages of any nature caused by the product. We will not warrant damage from normal wear such as scratches and dings.

For more information about our dealers and distributors, please contact our customer service at support@acinfinity.com or (626) 923-6399 Monday to Friday (9:00 am to 5:00 pm PST).



If you have any issues with this product, contact us and we'll happily resolve your problem or issue a full refund!

COPYRIGHT © 2021 AC INFINITY INC. ALL RIGHTS RESERVED

No part of the materials including graphics or logos available in this booklet may be copied, photocopied, reproduced, translated or reduced to any electronic medium or machine readable form, in whole or in part, without specific permission from AC Infinity Inc.

www.acinfinity.com